

REFERENCIA: PKAA000000000

Urven Park - H Modelo Simple Normal

CAPACIDAD: 3 FILAS DE MÓDULOS 60 CÉLULAS

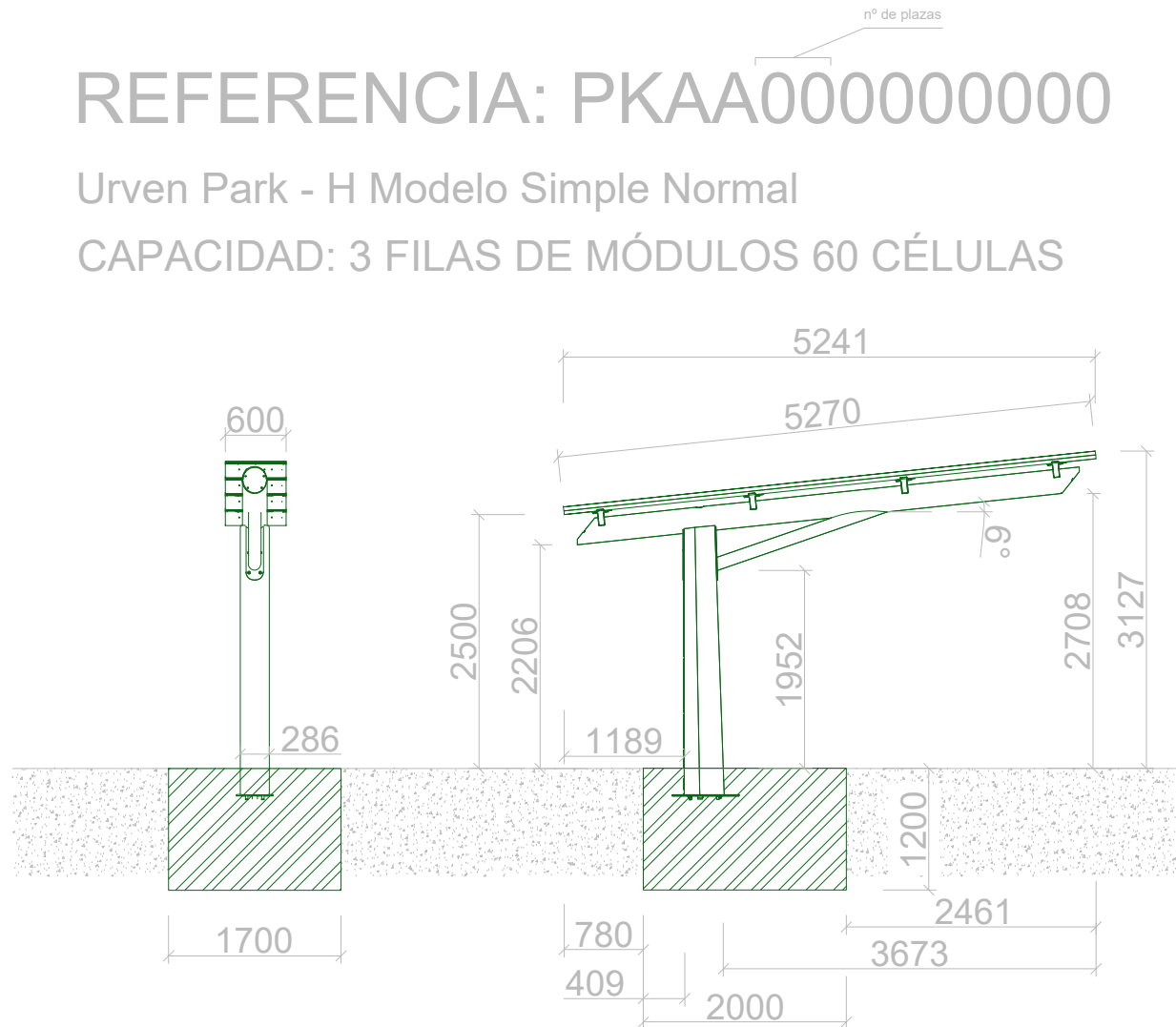

URVEN PARK - H

PILAR DE HORMIGÓN

GRIS OSCURO

VELA DE ACERO

EPOXI POLIAMIDA + POLIURETANO

ALIFATICO BLANCO BRILLO

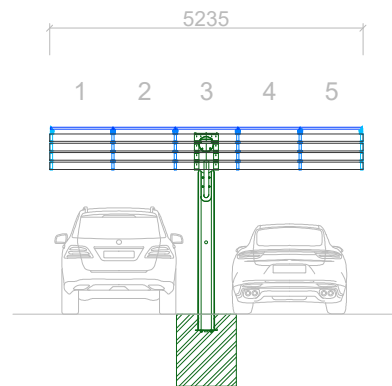
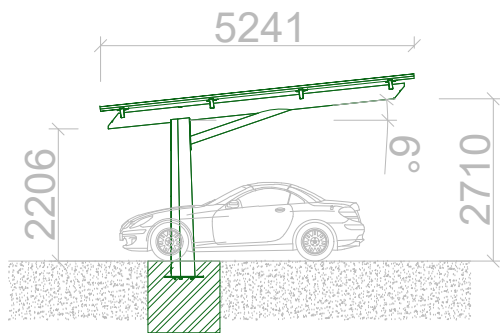

REFERENCIA: PKAA020000000

POTENCIA: 5,70 kWp

Nº MÓDULOS: 15

PLAZAS: 2

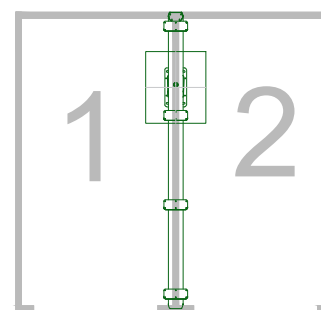

URVEN PARK - H

PILAR DE HORMIGÓN

GRIS OSCURO

VELA DE ACERO

EPOXI POLIAMIDA + POLIURETANO

ALIFATICO BLANCO BRILLO

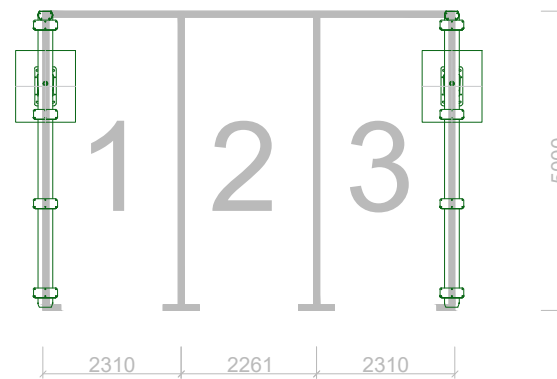
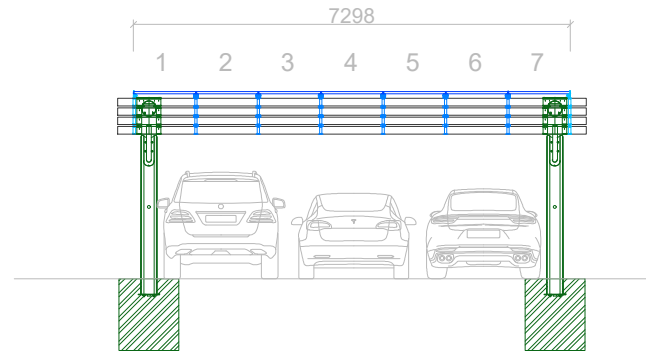
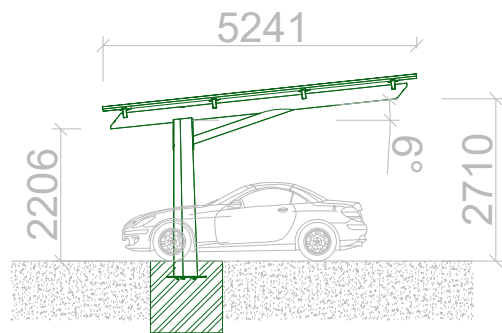

REFERENCIA: PKAA030000000

POTENCIA: 7,98 kWp

Nº MÓDULOS: 21

PLAZAS: 3



URVEN PARK - H

PILAR DE HORMIGÓN

GRIS OSCURO

VELA DE ACERO

EPOXI POLIAMIDA + POLIURETANO

ALIFATICO BLANCO BRILLO

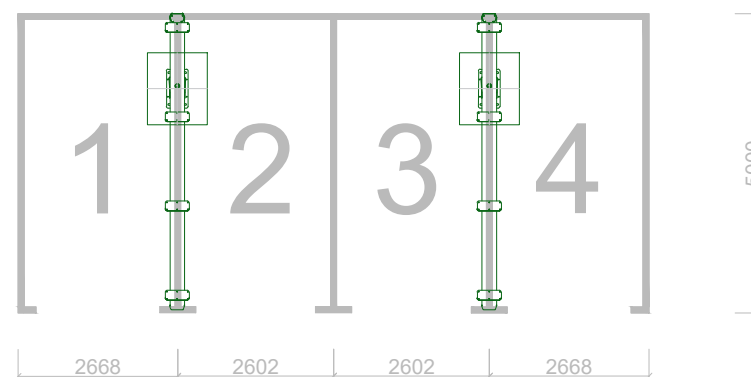
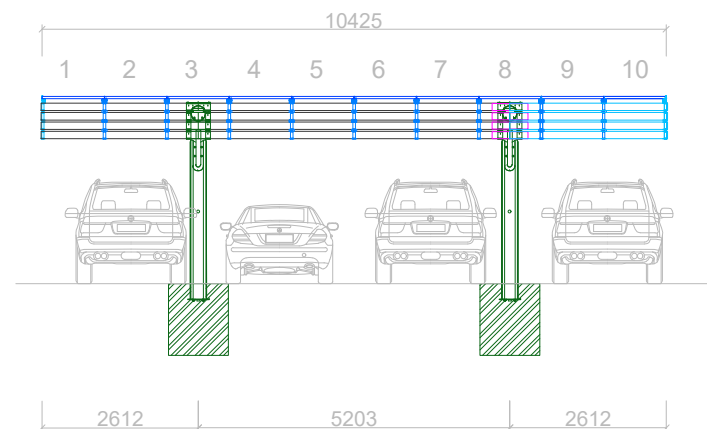
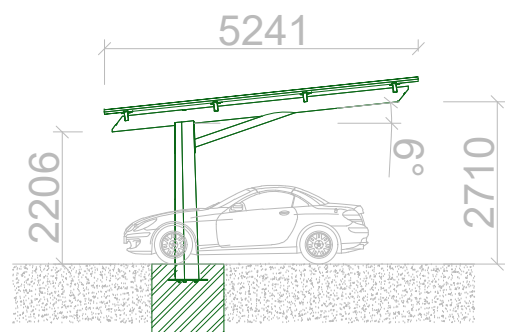

REFERENCIA: PKAA040000000

POTENCIA: 11,40 kWp

Nº MÓDULOS: 30

PLAZAS: 4



URVEN PARK - H

PILAR DE HORMIGÓN

GRIS OSCURO

VELA DE ACERO

EPOXI POLIAMIDA + POLIURETANO

ALIFATICO BLANCO BRILLO

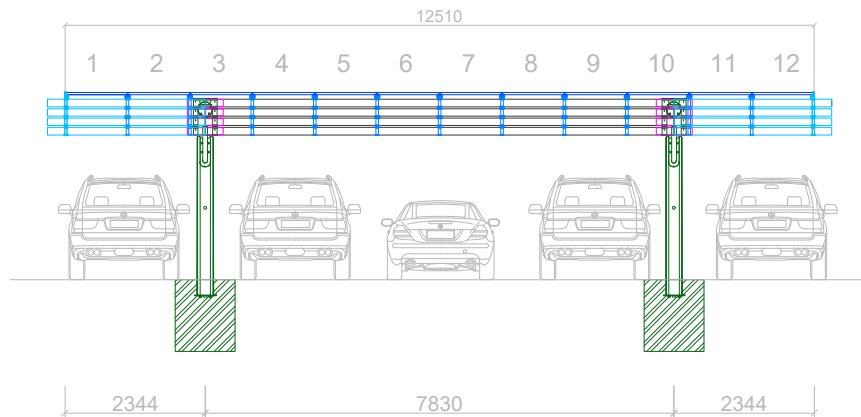
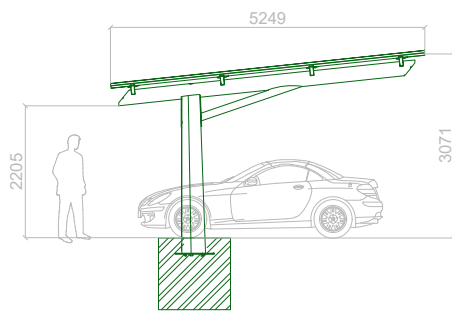

REFERENCIA: PKAA050000000
 POTENCIA: 13,68 kWp
 Nº MÓDULOS: 36
 PLAZAS: 5

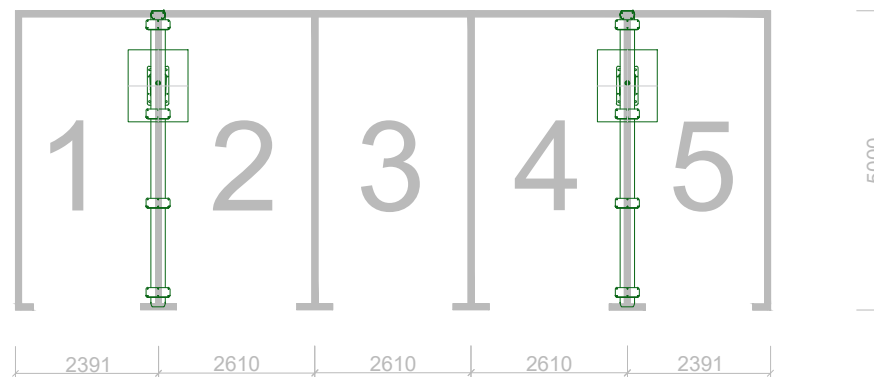

URVEN PARK - H

PILAR DE HORMIGÓN
 GRIS OSCURO
 VELA DE ACERO
 EPOXI POLIAMIDA + POLIURETANO
 ALIFATICO BLANCO BRILLO

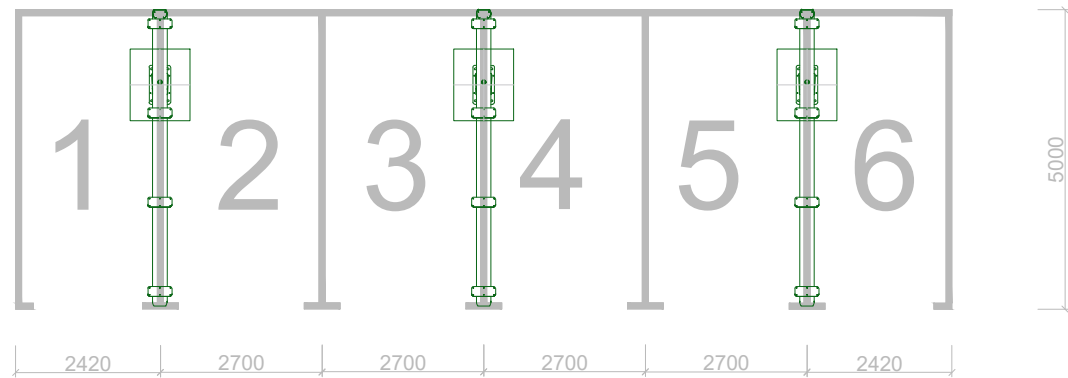
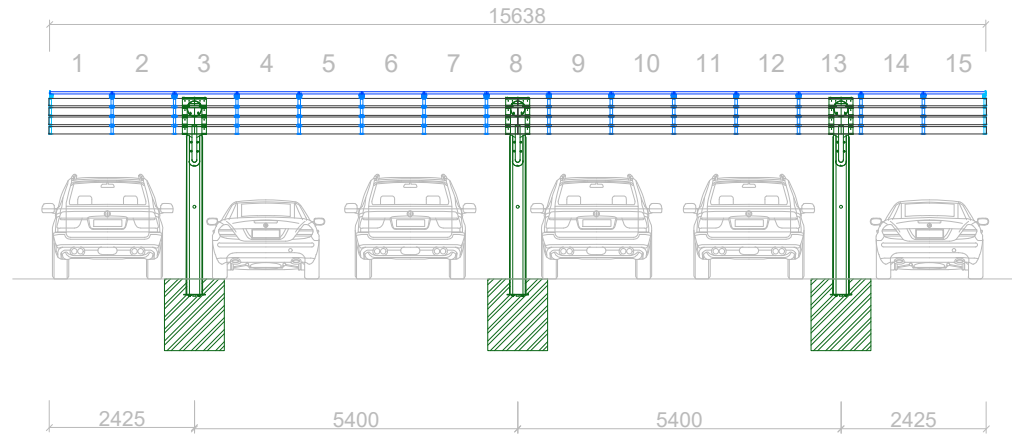
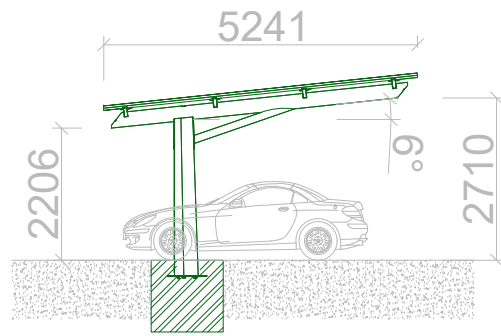

REFERENCIA: PKAA060000000
 POTENCIA: 17,10 kWp
 N° MÓDULOS: 45
 PLAZAS: 6



URVEN PARK - H

PILAR DE HORMIGÓN
 GRIS OSCURO
 VELA DE ACERO
 EPOXI POLIAMIDA + POLIURETANO
 ALIFATICO BLANCO BRILLO

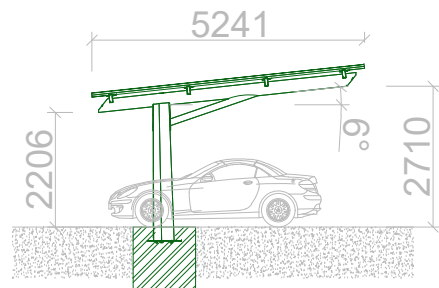

REFERENCIA: PKAA080000000

POTENCIA: 22,80 kWp

Nº MÓDULOS: 60

PLAZAS: 8

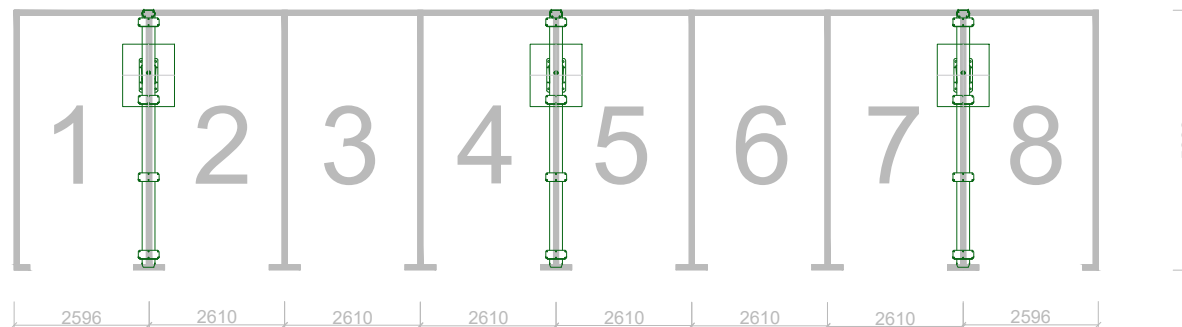
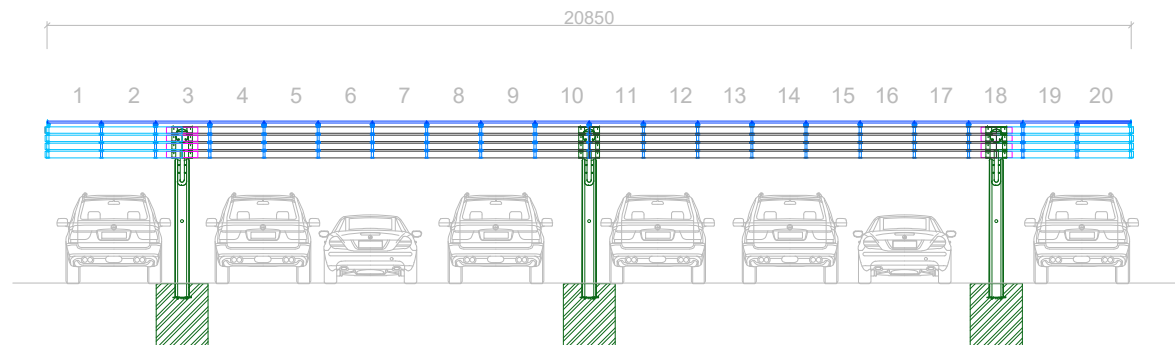

URVEN PARK - H

PILAR DE HORMIGÓN

GRIS OSCURO

VELA DE ACERO

EPOXI POLIAMIDA + POLIURETANO

ALIFATICO BLANCO BRILLO

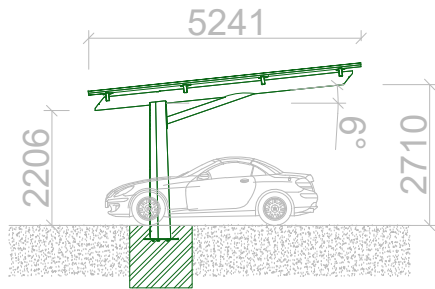

REFERENCIA: PKAA100000000
 POTENCIA: 28,50 kWp
 Nº MÓDULOS: 75
 PLAZAS: 10

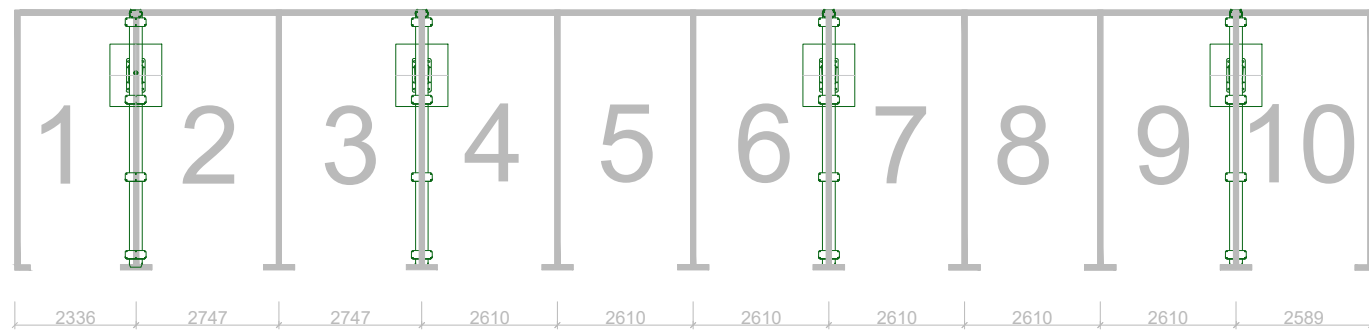
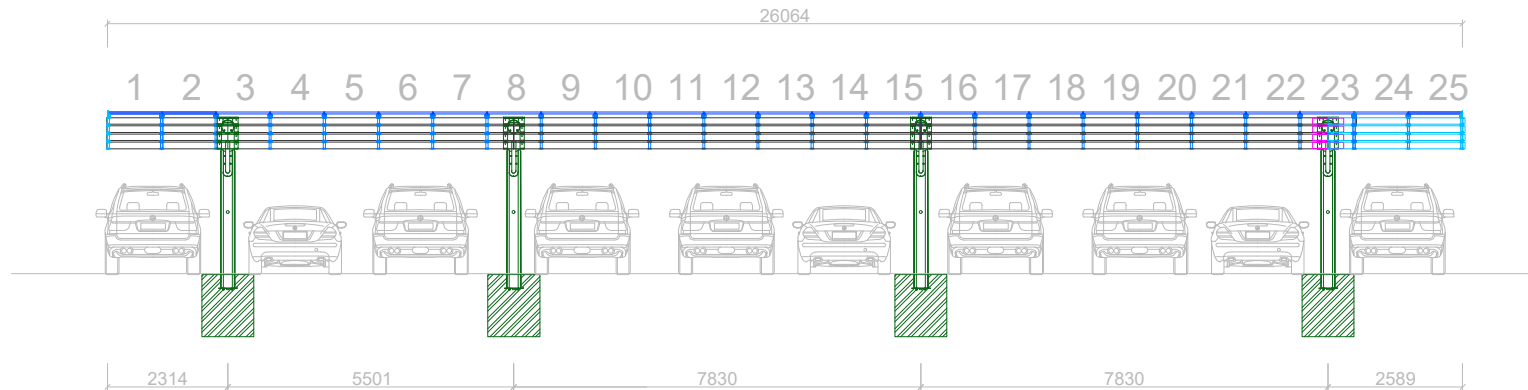

URVEN PARK - H

PILAR DE HORMIGÓN

GRIS OSCURO

VELA DE ACERO

EPOXI POLIAMIDA + POLIURETANO

ALIFATICO BLANCO BRILLO

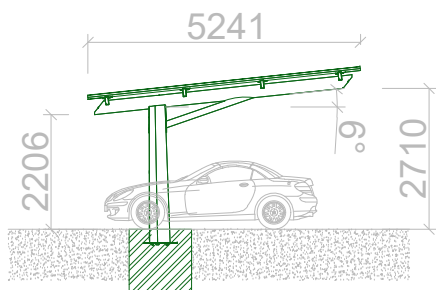

REFERENCIA: PKAA110000000

POTENCIA: 30,78 kWp

Nº MÓDULOS: 81

PLAZAS: 11

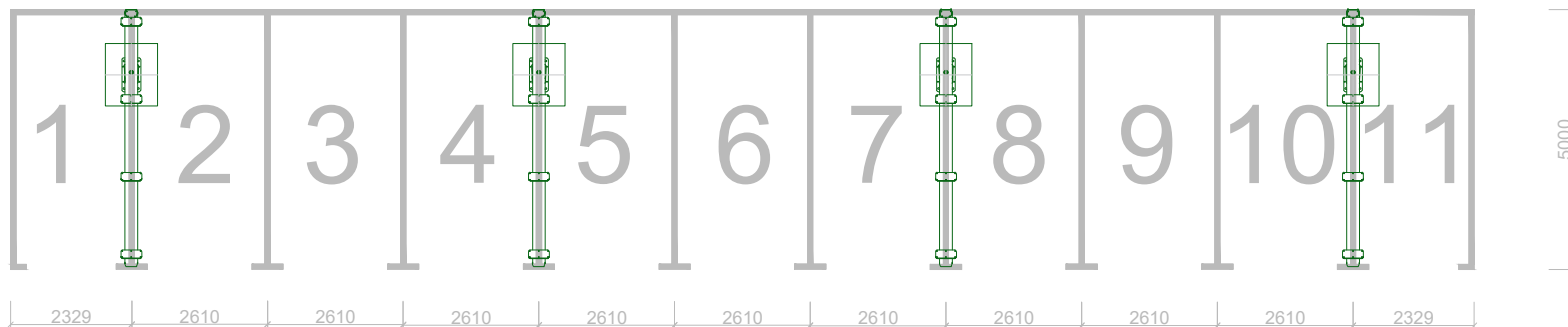
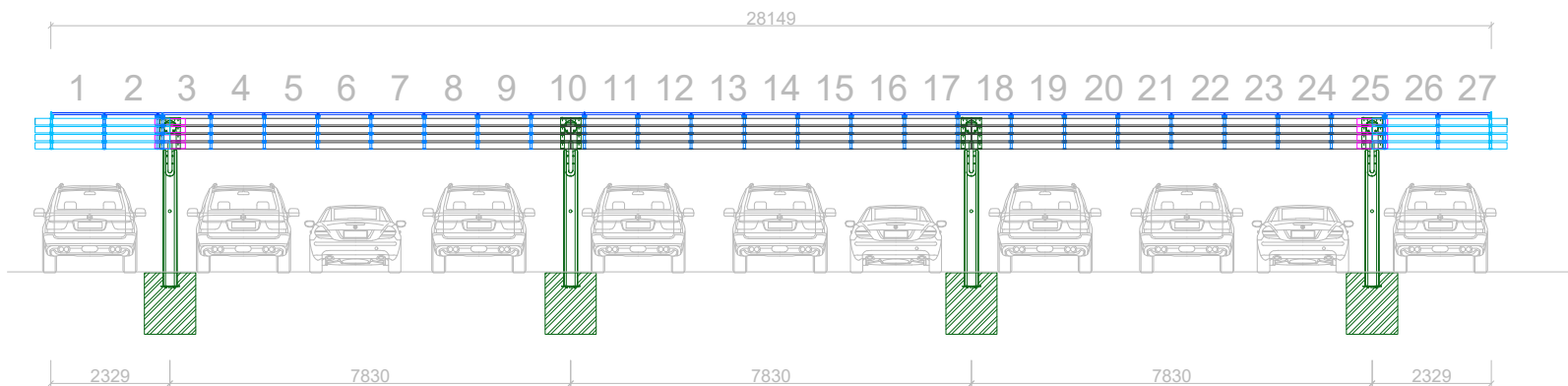

URVEN PARK - H

PILAR DE HORMIGÓN

GRIS OSCURO

VELA DE ACERO

EPOXI POLIAMIDA + POLIURETANO

ALIFATICO BLANCO BRILLO

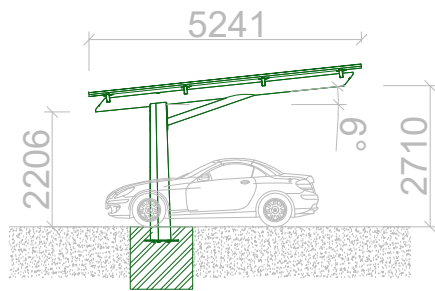

REFERENCIA: PKAA120000000

POTENCIA: 34,20 kWp

Nº MÓDULOS: 90

PLAZAS: 12

31320

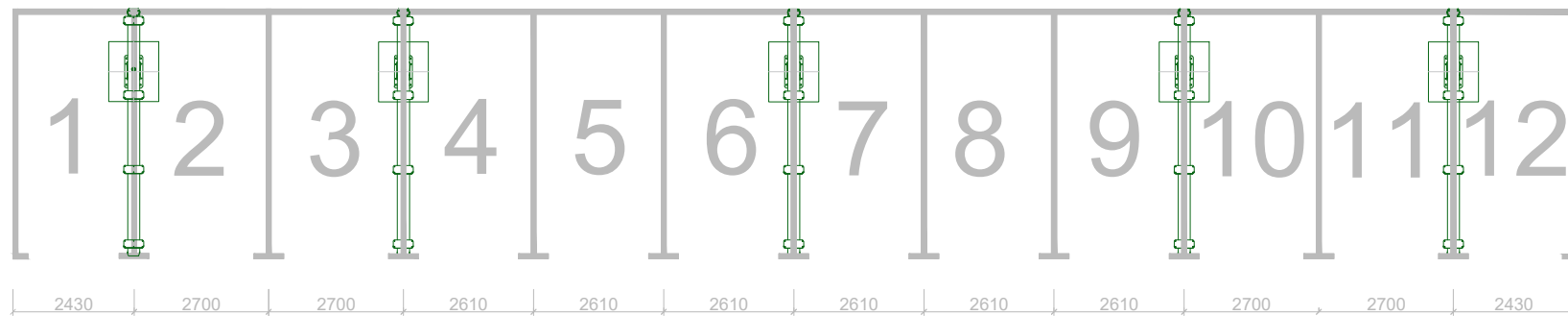
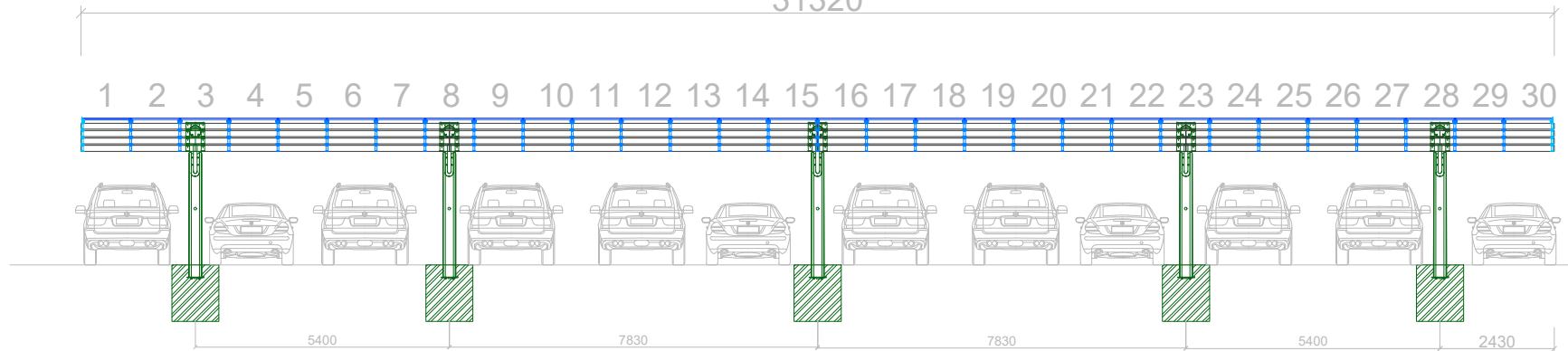

URVEN PARK - H

PILAR DE HORMIGÓN

GRIS OSCURO

VELA DE ACERO

EPOXI POLIAMIDA + POLIURETANO

ALIFATICO BLANCO BRILLO

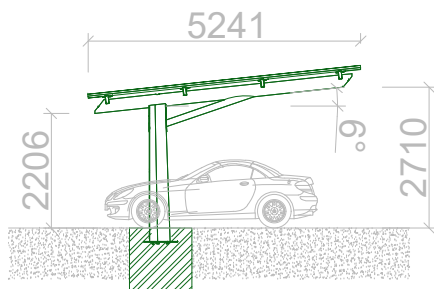

REFERENCIA: PKAA140000000

POTENCIA: 39,90 kWp

Nº MÓDULOS: 105

PLAZAS: 14

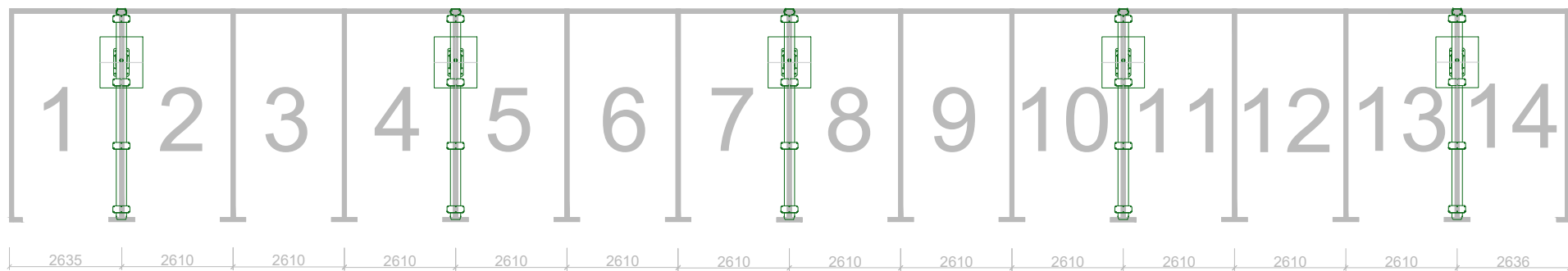
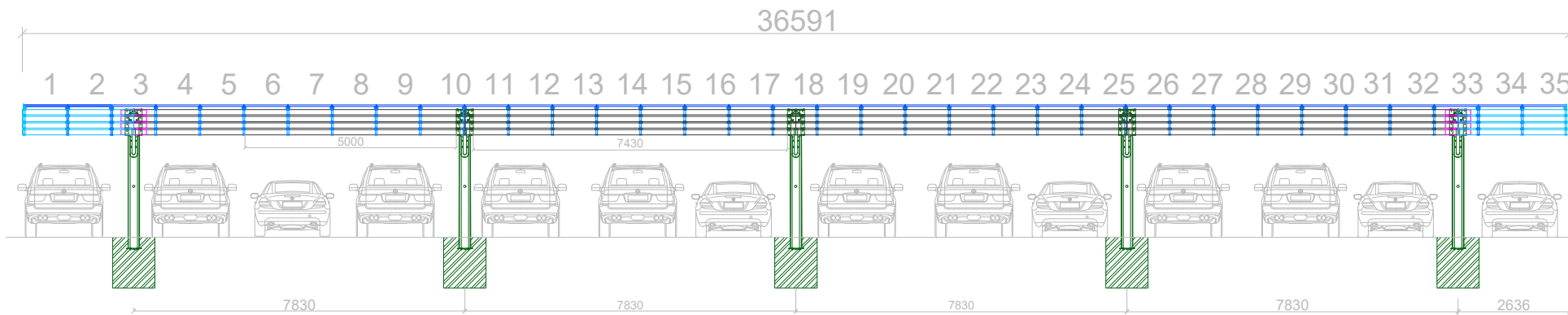

URVEN PARK - H

PILAR DE HORMIGÓN

GRIS OSCURO

VELA DE ACERO

EPOXI POLIAMIDA + POLIURETANO

ALIFATICO BLANCO BRILLO

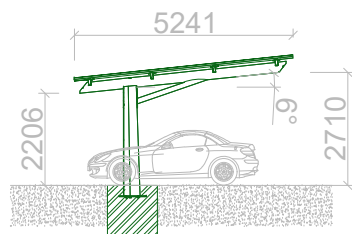

REFERENCIA: PKAA160000000

POTENCIA: 45,60 kWp

Nº MÓDULOS: 120

PLAZAS: 16

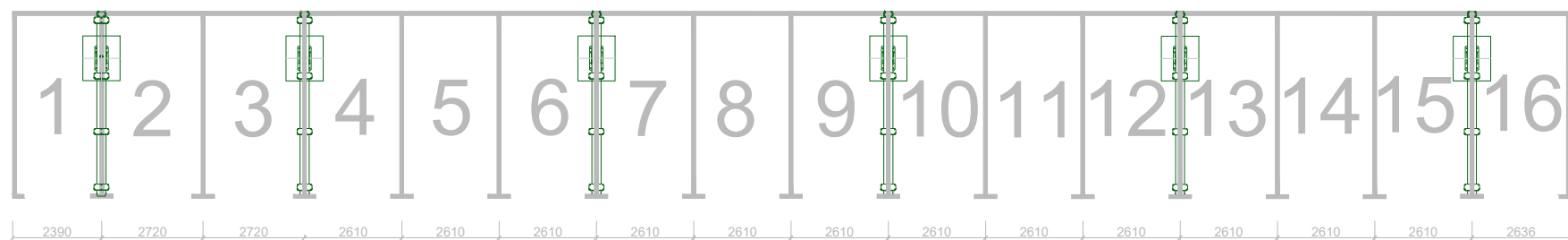
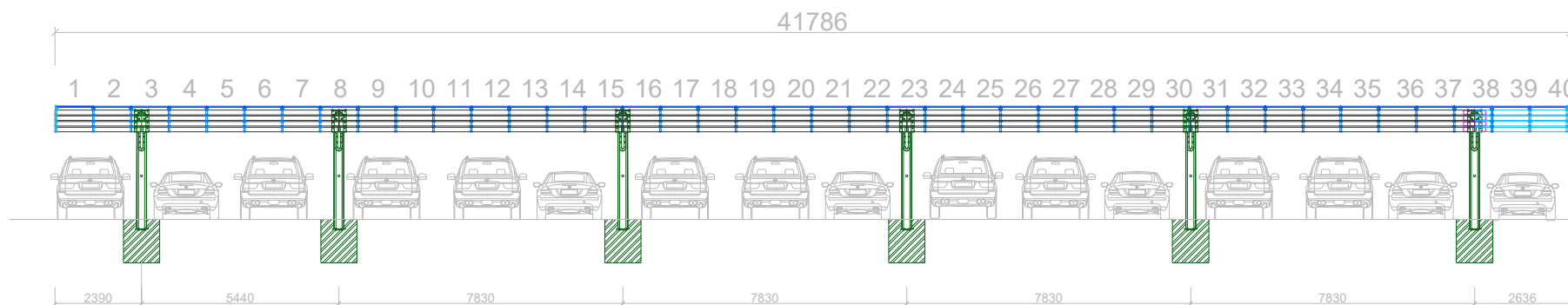

URVEN PARK - H

PILAR DE HORMIGÓN

GRIS OSCURO

VELA DE ACERO

EPOXI POLIAMIDA + POLIURETANO

ALIFATICO BLANCO BRILLO

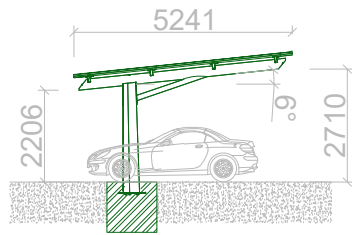

REFERENCIA: PKAA170000000
 POTENCIA: 47,88 kWp
 Nº MÓDULOS: 126
 PLAZAS: 17

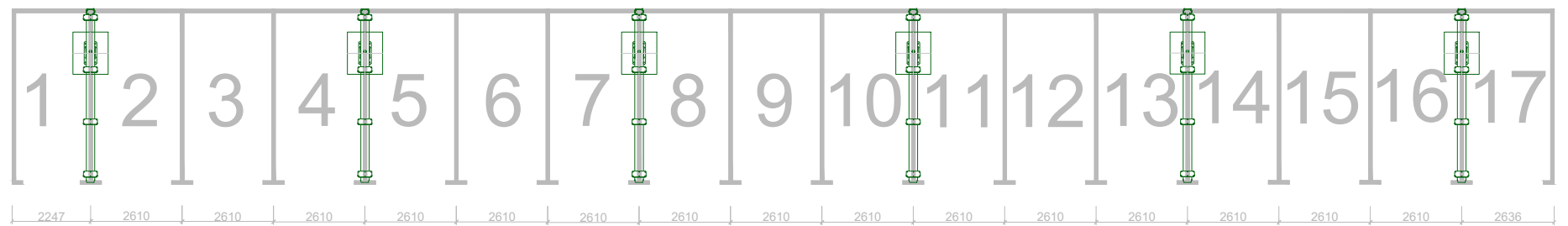
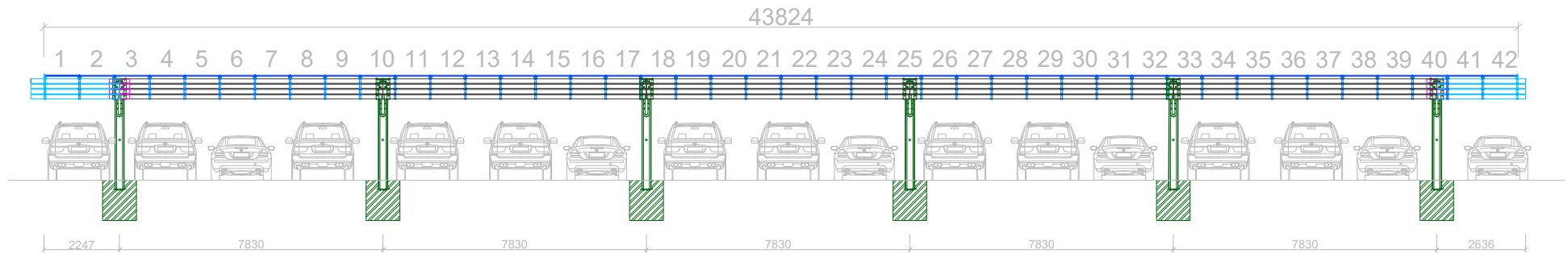

URVEN PARK - H

PILAR DE HORMIGÓN

GRIS OSCURO

VELA DE ACERO

EPOXI POLIAMIDA + POLIURETANO

ALIFATICO BLANCO BRILLO

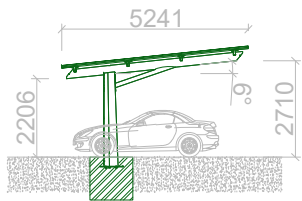

REFERENCIA: PKAA200000000
 POTENCIA: 47,88 kWp
 N° MÓDULOS: 126
 PLAZAS: 17

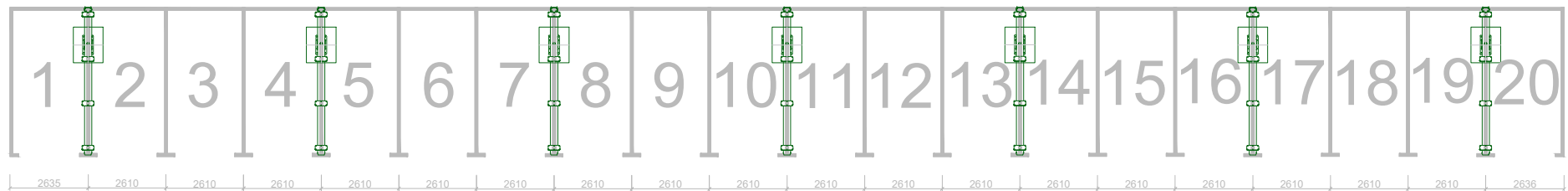
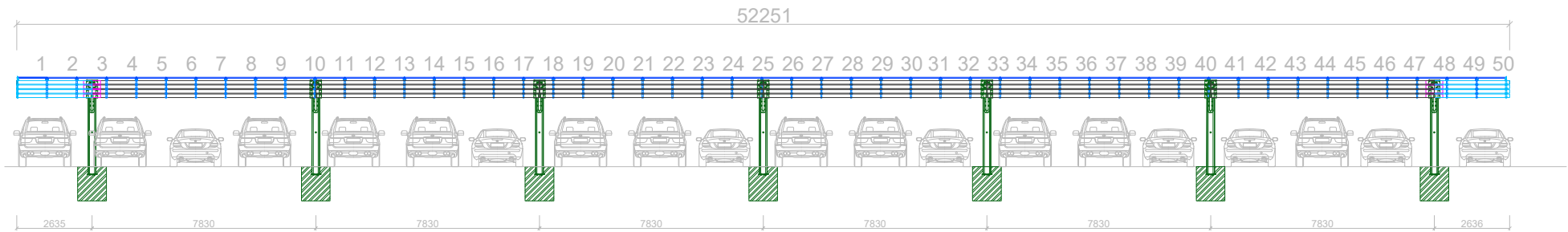

URVEN PARK - H

PILAR DE HORMIGÓN

GRIS OSCURO

VELA DE ACERO

EPOXI POLIAMIDA + POLIURETANO

ALIFATICO BLANCO BRILLO